

Smart Temp Thermostats

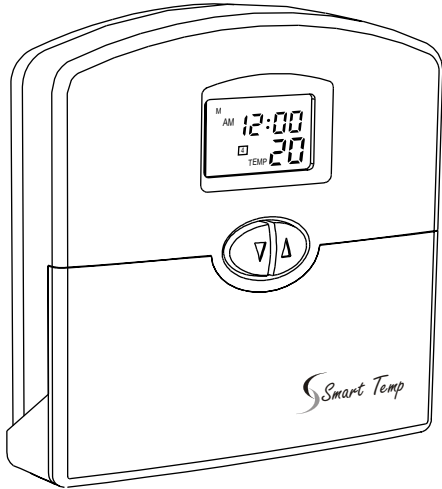

Model 42 157 Owners Manual

Congratulations on the purchase of your new Electronic Thermostat!

Your new Smart Temp thermostat has been built using the best components and design philosophy. As a result, if properly installed your new electronic programmable thermostat will provide you with years of trouble free and reliable service.

The Smart Temp 42-157 has been designed to be attractive, highly reliable and simple to use. Please take the time to read these simple instruction to familiarise yourself with the function and features offered in this product.

Operation

Great effort has gone into making the Smart Temp electronic thermostat an extremely simple thermostat to program and use. By reading and understanding these simple instruction, you will realise and use many of the features this thermostat has to offer.

Programming and set up of this product has been designed as a very methodical procedure. The same buttons (and sequence of buttons) are used to program and set up this product.

Setting The Clock

As the 42-157 thermostat is a programable thermostat, when you first place the batteries into the thermostat, (or after you have pressed the reset button) you must set the real time clock. This is essential as the 42-157 thermostat uses this clock to turn on the heating and cooling at the times that you require.

Setting the clock is a simple procedure that only requires a few key presses. When the batteries are first installed, the LCD will indicate the current room temperature and 12AM on the Clock as shown in Fig 1.

In this example, lets set the clock for 2:16PM on Saturday.

Step 1

Press the **(DAYTIME)** button, the display will illuminate, the temperature indication will go blank and the hours digits will flash as in fig 2.

Step 2

By pressing the **(V/A)** buttons adjust the hours to read 2PM.

Step 3

Press the **(DAYTIME)** button again. Now the minutes flash. Pressing the **(V/A)** will permit you to adjust the minutes to "16".(Fig 3)

Step 4

Press the **(DAYTIME)** button again. Now the day will flash as in fig 4. Press the **(V/A)** to adjust the day to read "SA".

Step 5

Press the **(DAYTIME)** button again to return to normal mode. Alternatively by NOT pressing a button for 20 to 30 seconds the thermostat will automatically go back into normal mode. The clock is now set.

In this example, Pressing the **(DAYTIME)** button cycles through Hours, Minutes and Day. (Indicated by the flashing digit). By pressing the **(V/A)** button permits you to make adjustments to the flashing digit. This same principal is used through out the programming of this thermostat.

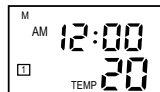

Fig 1

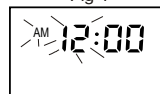

Fig 2

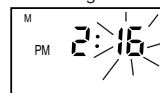

Fig 3

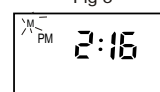

Fig 4

Programming the Thermostat.

The 42-157 is a "5+2" day programmable thermostat; 1 program group is for the 5 weekdays, 1 program group is for the weekend, hence the 5+2. Further to this, the 42-157 has 4 programs per day. What this means is that up to 4 times each day the thermostat will change the temperature of the home.

As an example, in heating mode - just before you get out of bed in the morning you may want the home to heat to 20 Deg (Program 1). While you are at work you may not want the house to get any colder than 15 Deg (Program 2). Just before you arrive home at the end of the day you may wish the home to be at 21 deg (Program 3), and while you sleep at night you may want the home to be kept at a cosy 17 Deg (Program 4).

Programming this thermostat is no more difficult than setting the clock. In programming mode however the thermostat will cycle between Hours, Minutes and Temperature for Program 1. By continuing to press the program button it will continue to cycle through Hours, Minutes and Temperature for Program 2. Then Hours Minutes and Temperature for Program 3 etc.

Again, after 20 to 30 seconds of NOT pressing a button the thermostat will return to normal mode.

Step 1

Use the **(HEAT/OFF/COOL)** switch to select either heating mode or cooling mode.

(Please note: This thermostat is capable of controlling both a Heating & Cooling system, The use of this thermostat does not indicate that your home or office has a Heating AND Cooling system installed)

Step 2

Press the **(PROGRAM)** button. Program "1" indicator as well as the Weekdays will be displayed. The "HOURS" and AM or PM on the LCD will flash. (See fig 5) Press the **(V/A)** button to adjust the hour to the time you wish the first program to start.



FIG 5

Step 3

Press the **(PROGRAM)** button again. Now the minutes will flash for program "1". Press the **(V/A)** button to adjust the minutes to the time you wish the first program to start.

Step 4

Press the **(PROGRAM)** button again. Now the Temperature for program "1" will flash. Again, by pressing the **(V/A)** buttons you can adjust the desired temperature for program "1"

Pressing the program button again simply repeats the above procedure for Programs 2, 3 & 4 for the weekdays, then the 4 weekend programs (indicated by "SA SU" in the LCD).

Tip.

If you only require 2 or 3 programs per day, simply set the unrequired programs to the same value as a used program. For example, should you only require 2 programs for the weekend (wake at 7:00am at 20 deg and Sleep at 11:00pm at 17Deg. Simply set program 1, 2 & 3 for 7:00 am at 20Deg and program 4 for 11:00pm at 17Deg. This way, at 7:00 the thermostat will move straight to program 3, and stay in program 3 until 11:00 pm (program 4 start time)

To adjust the Cooling program. Repeat the above procedure with the **(HEAT/OFF/COOL)** switch in the "Cool" position.

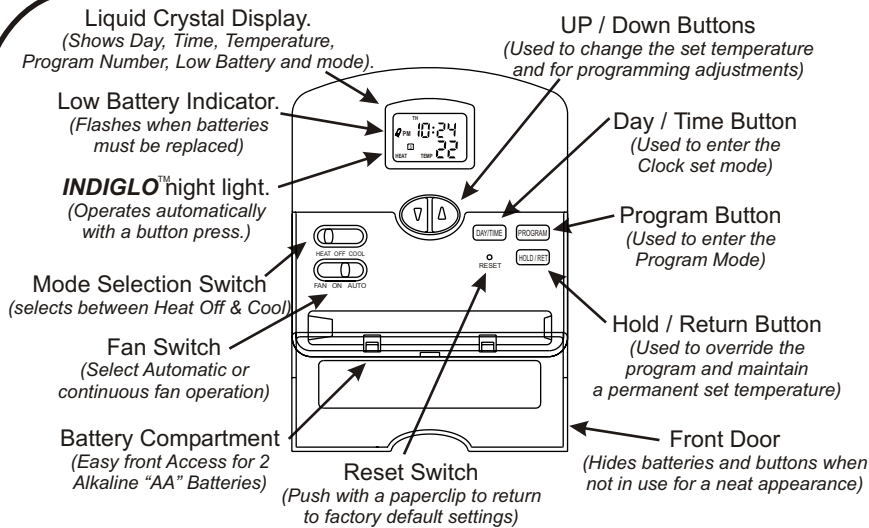

Default Program

Note: All seven days have the same values

Program Number	Time	Temperature Deg C	
		Heat	Cool
1	6:00 AM	20 C	26 C
2	8:00 AM	16 C	29 C
3	4:00PM	20 C	26 C
4	10:00 PM	16 C	28 C

Fill out this table below with your settings

Heat mode

Day	Program 1	Program 2	Program 3	Program 4
Monday to Friday	Time	Time	Time	Time
Saturday & Sunday	Time	Time	Time	Time

Cool mode

Day	Program 1	Program 2	Program 3	Program 4
Monday to Friday	Time	Time	Time	Time
Saturday & Sunday	Time	Time	Time	Time

Override Functions

The Smart Temp 42-157 has two override modes. These are very useful should you wish to make changes to the set temperature without reprogramming the thermostat. The two override modes are described below.

Temporary Override

In this mode, the override temperature change will only last until the NEXT program starts, hence it being called a "temporary override." For example, you might use this type of override when you want the home to be a little warmer (or cooler) to accommodate a dinner guest. Adjusting the evening program (program 3) will only last until the sleep program (program 4) begins later that night, or until it is manually canceled as described below.

To make a Temporary Temperature Override.

Press and hold the button to change the LCD display to indicate the "SET" or desired temperature. After approximately 1 second, the display will blink once to indicate the temperature can be adjusted. Press and hold to adjust the set temperature to your new desired temperature. You will note that the Program indicator in the LCD will now flash to indicate that a temperature override is now active.

Permanent Override.

The Smart Temp 42-157 permits the permanent override of all temperatures and programs with a simple button press. This may be useful when you go on holidays and not wish to let the home cool below at 12 deg C, 24 hours per day, 7 days per week. Another common use of the permanent override is for those that may not wish to use the Smart Temp 42-157 thermostat as a programmable thermostat, and use it in a "manual thermostat mode", In this way you can select a desired permanent temperature and by using the switch turn the thermostat off or on manually as desired.

To make a permanent Temperature Override.

Should you wish to set a permanent temperature and override all program and clock functions first select heating or cooling mode using the switch. Next, using the buttons select the desired temperature. To lock this temperature permanently simply press the button. The thermostat will indicate "HOLD" in the LCD confirming the permanently hold function is active. It is then a simple matter to turn the thermostat off and on at the held temperature using the switch.

To turn OFF Temperature Overrides

When you no longer require a permanent temperature override and wish to resume normal time clock functions, programs and temperature set points, simply press the button. The "HOLD" symbol will no longer be shown in the LCD indicating normal thermostat functions have been resumed.

To turn off a temporary override simply press the button twice.

Additional Information

Low Battery Warning

The Smart Temp 42-157 is fitted with a two stage low battery warning. When the batteries are first detected to be weak the first stage Low battery warning will be indicated by the low battery symbol in the LCD. It is important to replace the batteries with Alkaline "AA" batteries when this symbol is flashing. When the batteries become too weak to maintain normal thermostat operation the thermostat enters the second stage low battery warning which shuts the thermostat down and flashes the word "BATT" in the thermostat display. During a battery replacement You have approximately 1 to 2 minutes once the batteries are removed to place fresh alkaline batteries in the thermostat before program data is lost.

Please note: the back light function is suspended when the low battery indicator is on.

12 or 24 Hour Clock

This thermostat is able to display the time in the conventional 12 hour "AM / PM" or the 24 Hour time format. To change the time format press the button then the button to toggle between both time formats.

Span Mode

Your thermostat is set at the factory to maintain the room temperature to within 1/2 deg C of the set (or desired) temperature. For example, in heat mode if the set temperature is 20 Deg C. The 42-157 will turn the heating on at 19.5 deg C and off again at 20.5 deg. This setting has been chosen as it provides the most comfortable environment under most conditions. However, if you find the system cycling (turning off and on) to quickly or slowly, the thermostats cycle rate can be increased or decreased with the "Span" setting.



Fig 6

To enter the "Span" adjustment mode press both the buttons together for 5 seconds. The display will indicate the factory default "Span 2". (Fig 6) By pressing the buttons will increase or decrease the span setting. Span 2 is the factory default setting. Span 1 decreases the cycle rate, Span 3 increases the cycle rate. The Span setting effects both the heat and cool mode equally.

To exit the Span mode, simply press and hold both The buttons for 5 seconds.

Making Life Comfortable

LCD Back light (**INDIGLO**)

This thermostat is fitted with an electroluminescent lamp which activates for easy viewing in the dark. When any button or switch is pressed the display is illuminated. This back light will remain on for 5 seconds after the last button is pressed.

Please note:

If the thermostat is in a low battery condition, the back light will not operate. It is important to replace the batteries with two new "AA" Alkaline batteries when a low battery condition exists.

If the ambient noise level is very low, a quite high pitched sound may be heard when the back light is on. This is a normal sound made by the thermostat when the back light is on and is not a malfunction.

Error Messages

If the thermostat is unable to control your system due to an unexpected problem the 42-157 thermostat will enter "Error mode". In this condition the thermostat flashed "Err" on the LCD (fig7).

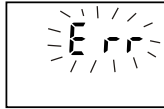

Fig 7

In the extremely unlikely event that your thermostat enters this mode it is recommended that you immediately replace the thermostat batteries with a new set of "AA" Alkaline batteries (even if you have just replaced the batteries).

Next, using a paperclip press the reset button which can be found directly under the **(DAYTIME)** button. You will now need to set the clock and re program the thermostat to ensure correct thermostat operation.

Troubleshooting

No Display.

1. Check batteries.
2. Press reset and reprogram.

Display Dims.

1. Replace Batteries.

No Back light

1. Replace Batteries.

Program does not change at your desired Setting.

1. Check the time is set properly, note the AM / PM indicator.
2. Check that the thermostat is NOT in Hold mode.
3. Check that the thermostat shows the correct day.

Heating or Cooling does not go On or OFF.

1. Check that the function switch is in the correct position.
2. Some systems require a delay between switching modes.
3. Check circuit breakers (fuses) to equipment.
4. Make sure pilot light (if applicable) on furnace is lit.
5. Replace Batteries in thermostat.

Erratic Display.

1. Replace batteries.

Thermostat permanently displays "HI", "LO" or "Err".

1. Replace Batteries and reset.
2. Replace thermostat.

Also Available from Smart Temp The **Smart Zone** Climate System Zoning Solution

Each zone controls the system independently.

The *Smart Zone* will call for heating or cooling, regardless of the other zones requirements. This is almost like having two separate systems. (Note, Both heating & cooling can't run at the same time.)

Each Zone has its own timer, sensor and set temperature.

Because the *Smart Zone* is like two separate systems, the temperature is measured in the zone being heated or cooled. Further, each zone has its own time clock, therefore automatically turning on the heating or cooling when you have programmed it!

Divide your home into Living and Sleeping Zones.

Using the *Smart Zone* you are able to heat or cool the living zones during the day, and the sleeping zones during the night. Save energy by only heating or cooling the zones your occupying.

Have two separate temperature Zones

As the *Smart Zone* is like having two completely independent heating or cooling systems, each zone can set separate comfort levels. Therefore eliminating the problem of the upstairs overheating while maintaining a comfortable temperature downstairs.

Ideal for Shared accommodation.

If you have a family member living with you, by zoning their area of the home they have control over their comfort level while leaving your settings unaffected. This also saves on energy costs as you only heat or cool the occupied area of the home.

A home climate zoning system can reduce energy costs by up to 50% while improving home comfort.

An example of what the system does

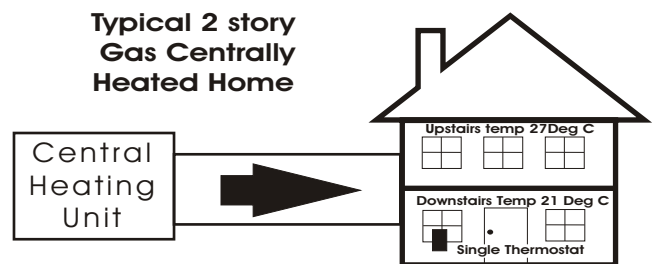

Zoned Gas Centrally Heated home.

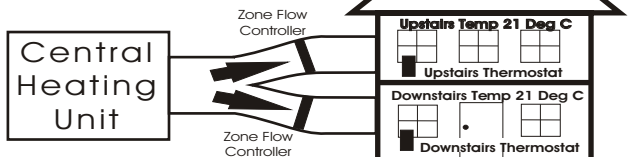

The *Smart Zone* control board maintains the correct temperature in the zoned home by controlling the gas central heating unit and opening or closing the appropriate flow control damper(s) to the zone(s) that require heating.

This ensures the correct temperature is maintained throughout your entire home.

Installation Instructions

⚠ Note:

These instructions assume the installer of this thermostat has Knowledge of Heating & Air conditioning systems, the terminology used in these systems and of the HVAC industry requirements.

It is an offence in Australia for unqualified persons to make any changes to Airconditioning systems.

Failure to observe this may void equipment and thermostat warranty, property insurance and cause irreparable damage to the thermostat or equipment connected to it.

Remove the wall plate from the rear of the thermostat by pressing the release tab on the base of the thermostat. (Fig 8)

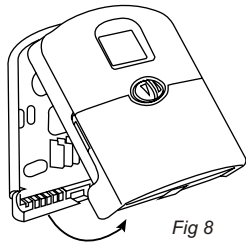

Fig 8

Position the wall plate on the wall and pull the wires through the large opening. Mount the wall plate with the supplied wall anchors or other suitable means, ensure the thermostat base is level to add to the appearance of the installation.

Referring to the supplied wiring diagrams, connect the system wires to the appropriate terminals on the thermostat base plate. Ensure the screws are tightened securely to prevent potential future problems caused by loose connections. Push excessive wire length back into the wall cavity.

If the opening in the wall is large there may be a potential for a draft to blow through the wall cavity and onto the temperature sensor on the back of the thermostat. To ensure correct thermostat operation it is important to block this hole. Failure to do so may cause inaccurate or erratic system performance.

On the back of the 42-157 thermostat there are three clearly marked selector switches. These switches are used to select the temperature display format (deg C or deg F), the type of system the thermostat is controlling (heat pump or heat with add on cool) and whether the fan is called by the thermostat (HE) or by the system (HG)

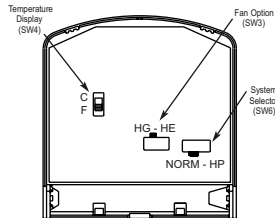

Fig 9

These switch locations are shown in Fig 9. Adjust these switches to their correct position.

Snap the two halves of the thermostat back together taking particular care to align the thermostat pins with the clips on the base plate of the thermostat (Fig 10).

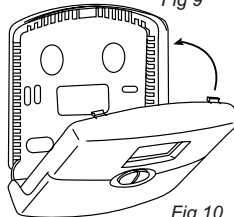

Fig 10

Set the thermostat to display the correct time and day taking particular care with the AM / PM and the day of the week. Ascertain the customers requirement and program the thermostat to the customers settings.

Test all thermostat modes by both raising the set temperature above the ambient temperature in heat mode and verifying correct heater operation. Next lower the set temperature to below the ambient temperature with the thermostat in Cool mode verify the correct operation of the equipment.

Leave a copy of these instructions for the future users of this thermostat

Should you have any questions or require any technical advice please call Smart Temp Australia P/L on (03) 9899 6455 during normal business hours.

The Smart Temp 42-157 thermostat has been designed to switch 24volt appliances only. Should you wish to control mains, 240VAC equipment an optional Smart Pak (P/N SP - 03) interface will be required. Please contact your place of purchase or Smart Temp Australia should this interface be required.

The Smart Temp 42-157 is a battery powered thermostat and does NOT require the use of a neutral. If this thermostat is replacing an existing line powered thermostat, disregard the neutral wire.

Failure to heed this warning WILL result in thermostat damage.

4 Wire Heat/Cool System

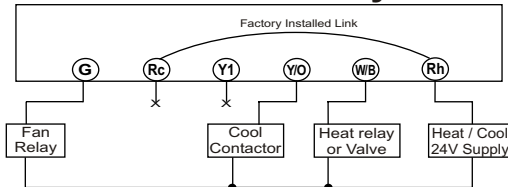

System Selector



5 Wire Heat/Cool System

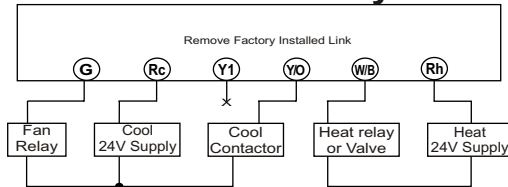

System Selector



Single Stage Heat Pump

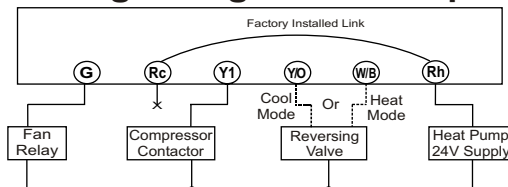

System Selector



2 wire Heat only system

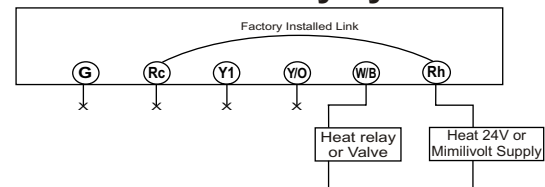

System Selector



3 wire Heat only system

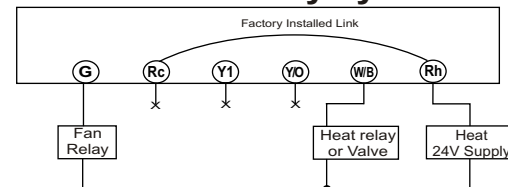

System Selector



3 wire Cool only system

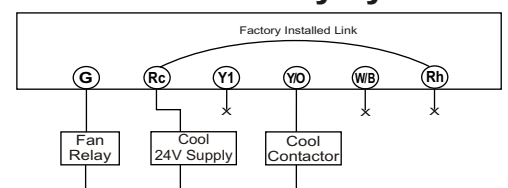

System Selector



Smart Temp Australia Pty Ltd
19 Indra Road Blackburn South 3130
Phone: (03) 9899 6455 Fax (03) 9899 6454
www.smart-temp.com.au

Smart Temp
Thermostat™



Manual Operation of the Thermostat

Move Slide switch to heat position

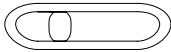

Heat

Do you want to Heat or Cool?

Cool

Move Slide switch to Cool position

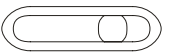

Press and hold the up button



Set the desired temperature

There will be two temperatures shown on the display - The top one is the set temperature and the bottom is the room temperature

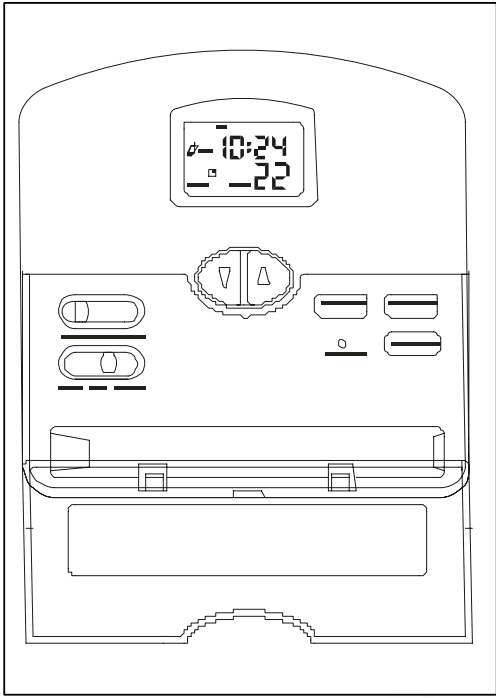

Press and hold the down button



Set the desired temperature

There will be two temperatures shown on the display- The top one is the set temperature and the bottom is the room temperature

Press the hold button twice.



"Hold" will be displayed on the screen

Press the hold button twice.



"Hold" will be displayed on the screen

This will hold the temperature indefinitely until the thermostat reaches its temperature, is turned off or if the "hold/ret" button is pressed (this will resume to the programming)

Typical Programs(Monday - Friday)		1 Heat		Cool		2 Heat		Cool		3 Heat		Cool		4 Heat		Cool	
a	Default Program	6:00am	20	26	8:00am	16	29	4:00pm	20	26	10:00pm	16	28				
b	Typical worker (9:00am - 5:00pm)	6:30am	21	23	8:00am	7	26	5:00pm	21	23	10:30pm	7	35				
c	Home all day	7:00am	21	23	7:00am	21	23	7:00am	21	23	11:00pm	15	35				
d	Always off(used in override function o	6:00am	7	35	8:00am	7	35	4:00pm	7	35	10:00pm	7	35				

Typical Programs(Monday - Friday)		1 Heat		Cool		2 Heat		Cool		3 Heat		Cool		4 Heat		Cool	
a	Default Program	6:00am	20	26	8:00am	16	29	4:00pm	20	26	10:00pm	16	28				
b	Typical worker	9:00am	21	23	11:30am	18	26	5:00pm	21	23	11:00pm	7	35				
c	Home All Day	8:00am	21	23	8:00am	21	23	8:00am	21	23	11:00pm	15	35				
d	Always off(used in override function o	6:00am	7	35	8:00am	7	35	4:00pm	7	35	10:00pm	7	35				

Programming the Thermostat

Move Slide switch to heat position

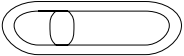

Press the button labeled **PROGRAM**
The Hour should be flashing

Adjust the hour by pressing the up/down buttons



If no changes are required jump to next step

Press **PROGRAM** again
The Minutes should be flashing

Adjust the minutes by pressing the up/down buttons



Press **PROGRAM** again
The Temperature should be flashing

Adjust the temperature by pressing the up/down buttons



Program 1 has now been programmed. Repeat steps for remaining programs 2,3 & 4 and for Saturday and Sunday

Do you want to program **Heat** or **Cool**?

The number **1** should appear in the bottom left hand corner

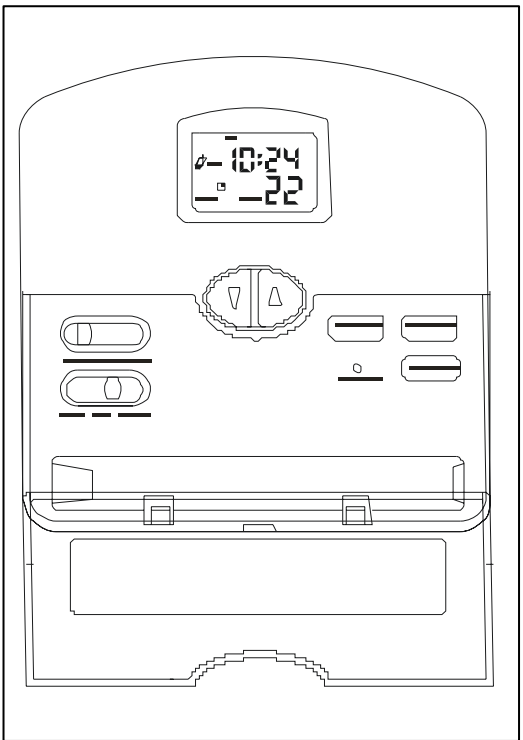

Move Slide switch to Cool position

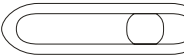

Press the button labeled **PROGRAM**
The Hour should be flashing

Adjust the hour by pressing the up/down buttons



If no changes are required jump to next step

Press **PROGRAM** again
The Minutes should be flashing

Adjust the minutes by pressing the up/down buttons



Press **PROGRAM** again
The Temperature should be flashing

Adjust the temperature by pressing the up/down buttons



Program 1 has now been programmed. Repeat steps for remaining programs 2,3 & 4 and for Saturday and Sunday